

# Plexo IP 55/IP 66

Makes your day,  
rain or shine



PLEXO / WEATHERPROOF WIRING DEVICES

 **legrand**<sup>®</sup>

[www.legrand.com.sg](http://www.legrand.com.sg)

# Plexo IP 55

## Ingenious features for easy installation

→→ Time saving guaranteed: no cut-out



→→ Inserting 4 to 15 mm diameter cables



1/ Pierce the end cap using a screwdriver



2/ Insert the cable through the end cap



3/ The membrane of the end cap ensures IP 55 protection of the installation

→→ Inserting 16 to 25 mm diameter tubes



1/ Make the end cap cut-out by pulling the seal



2/ Insert the tube through the end cap



3/ The membrane of the end cap compensates for any misalignment of the tube and ensures IP 55 protection of the installation

→→ **Automatic terminals for safety and speed**



Suitable for both **non-rigid multi-strand** and rigid cables.

→→ **Yet more ingenious features**

Plexo has many new improved or ingenious features to aid installation. Like, for example, the four 1/4 turn fastenings, the visible fixing points, etc.

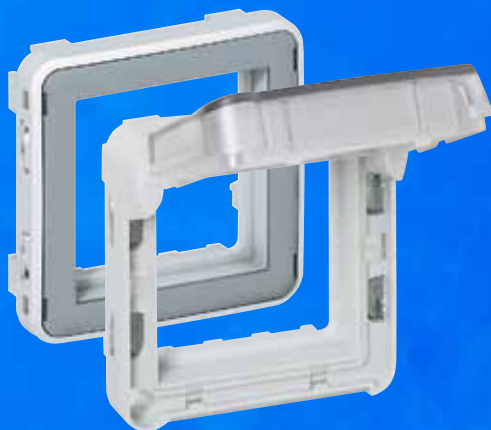

Plexo adaptors for Arteor, with or without flap



All the modular boxes are equipped with an automatic Nylbloc connector when a tap-off is required



Visible and accessible fixing points; identical to the Plexo 55



Locking by means of four 1/4 turn fastenings

# Plexo IP 55

## The functions that make Plexo a real new range

### →→ Plexo IP 55 is evolving for you

Many new functions are being added to Plexo range to satisfy all configurations, whatever your site. In addition, all control mechanisms with an indicator light or tell-tale are supplied with their bulb for insertion. Simple and practical!



2-wire automatic switch without override  
Cat.No 0 695 00 (p. 08)



Time switch for all loads  
Cat.No 0 695 04 (p. 07)



Push button with 1/4 turn unlocking  
Cat.No 0 695 49 (p. 09)



FTP cat. 6 Data socket  
Cat.No 0 695 69 (p. 08)

## Plexo IP 55 – IK 07

surface and flush mounting, supplied complete



0 697 11



0 697 12



0 697 33



0 698 24

Mechanisms supplied complete, with back box and 2 membrane glands.  
Illuminated functions supplied with 230 V~ lamps  
Lamps and accessories (p. 06). Automatic connection

### Switches 10 AX - 250 V~

Pack	Cat.Nos	IP 55 — IK 07	
10 5	0 697 11 0 697 16		Two-way switch Intermediate switch
10	0 697 12		Two-way switch with indicator
5	0 697 13		Illuminated two-way switch
10	0 697 15		Two-gang two-way switch

### Double Pole Switch

1	0 697 17		Double pole switch
---	----------	--	--------------------

### Push-buttons 10 A

Pack	Cat.Nos	IP 55 — IK 07	
1	0 697 20		N/O contact
10	0 697 22		Illuminated N/O contact

### Movement detectors

Pack	Cat.Nos	IP 55	
1	0 697 40		Allows control of a lighting device as soon as the movement is detected Maximum load: - 2 000 W for incandescent and halogen lamps 230 V~ and - 2 000 W for ELV halogen lamps, - 1 000 VA for fluorescent tubes and compact fluorescent lamps Detection range from 0 to 12 m Coverage pattern adjustable during installation process Temporization between 12 s and 16 min. Dim. 90x90x85 mm Detection angle : 360°

### Key switches 10 A - 250 V~

Pack	Cat.Nos	IP 20 — IK 07	
1	0 697 06		Key switch for European standard lock 1 pole, switch/push button 3 positions "1-0-2" To be equipped with lock Cat.No 0 696 95 below
1	0 697 95		European standard lock Supplied with one set of 3 keys

### Cable outlet

Pack	Cat.Nos	IP 55 — IK 07	
5	0 697 45		Cable outlet supplied with cable grip

### Socket outlets

Pack	Cat.Nos	IP 55 — IK 07	
10	0 697 33		German standard 16 A — 250 V~ 2P + E with earth lateral contact with screw terminals
5	0 696 72 SSO		British standard 13 A — 250 V~ 2P+E switched socket outlet, 16A switch and 13A socket
10	0 697 32		2P+E screw terminals
5	0 697 39		2 x 2P+E screw terminals
10	0 697 31		French standard 16 A — 250 V~ 2P + E with shutters for child protection, automatic terminals

### Switches 10 AX — 250 V~

Pack	Cat.Nos	IP 55 — IK 07	
10	0 698 11		Two-way switch

### Push-buttons 10 A

Pack	Cat.Nos	IP 55 — IK 07	
10	0 698 21		Illuminated changeover push-button (N/O + N/C contact)
5	0 698 24		Illuminated changeover push-button (N/O + N/C contact), with label holder Supplied with 12 V lamp Can be equipped with 230 V~ lamp

## Plexo IP 55 – IK 07

surface mounting boxes and flush-mounting support frames



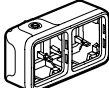
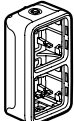
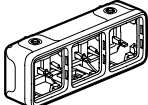

To be equipped with modular Plexo mechanisms (p. 07 to 09)

The surface mounting boxes are equipped with Nylbloc automatic connection terminals for 2 wires (optional use for junction)

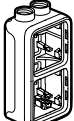
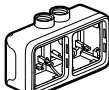
Pack	Cat.Nos	Surface mounting boxes with membrane glands
10	0 696 51	<p>Equipped with removable membrane glands. Direct entry of cables (No need to be cut)</p> <p><b>1 gang</b>   1 entry</p>
5	0 696 72	<p><b>2 and 3 gang</b>            No separation between compartments, in order to facilitate the cabling operations and to allow the installation of pre-wired socket outlets</p> <p> 2 gang, 2 entries</p>
5	0 696 61	<p> 2 gang, vertical mounting 2 entries</p>
5	0 696 80	<p> 3 gang, horizontal mounting 3 entries</p>

Pack	Cat.Nos	Surface mounting boxes for cable glands
5	0 696 56	<p> 1 gang 1 entry</p>
5	0 696 68	<p> 2 gang, vertical mounting 2 entries (2 top)</p>
5	0 696 78	<p> 2 gang, horizontal mounting 2 entries (2 top)</p>

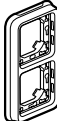
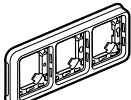
Pack	Cat.Nos	Flush-mounting support frames
10	0 696 81	<p>Used for flush mounting version for French and German standard boxes only</p> <p><b>1 gang</b>   For 1 Plexo mechanism            Can be equipped with claws            Cat.No. 0 849 00 / 01</p>
5	0 696 83	<p><b>2 and 3 gang</b>            71 mm fixing centres</p> <p> 2 gang, for 2 Plexo mechanisms, horizontal mounting</p>
5	0 696 85	<p> 2 gang, for 2 Plexo mechanisms, vertical mounting</p>
5	0 696 87	<p> 3 gang, for 3 Plexo mechanisms, horizontal mounting</p>

## Plexo IP 55 – IK 07 accessories

## Plexo IP 55 – IK 07 accessories



0 695 80



6 806 33



0 698 48

Installation with surface mounting boxes (p. 05) or flush mounting support frames (p. 05)

Pack	Cat.Nos		Pack	Cat.Nos	
10	 Grey/White 0 695 80	<b>Adaptors for 2-module Arteor mechanisms</b> Can be equipped with any 2-module Arteor functions (except specific mechanisms with depth > 18 mm) in order to obtain an IP 55 wiring device <b>Adaptor with smoked polycarbonate flap</b>  <b>Adaptor with smoked polycarbonate flap lockable</b> Lockable with special tool Cat.No 0 919 45  <b>Adaptor without flap - IP 20</b> 	5	0 695 37	<b>Blanking plate</b> To be used as needed in combination with surface mounting boxes or flush mounting frames
1	0 695 79		5	0 698 48	<b>Cable outlets</b> <b>IP 55 - IK 08</b> Cable outlet supplied with cable grip Ø5 to 13 mm
1	0 695 82		10	0 694 96	<b>Lamps</b> For indicator function use orange colour, For locator function use green colour 230 V - 1 mA green – exclusively used for illuminated push-button
20	 Grey/White 6 806 33 6 806 32	<b>Adaptors for 3-module Arteor mechanisms</b> Weatherproof IP 55 with membrane Allows operations of switches without opening cover maintaining IP 55 rating 	10	0 694 97	230 V - 0.5 mA green 230 V - 1 mA orange 12 V - 15 mA green 24 V - 20 mA green
20			10	0 694 98	
			10	0 694 99	
			10	0 694 95	
1	0 919 45	<b>Accessories</b> Special tool for adaptor Cat.No 0 696 79	10	0 695 96	<b>Membrane cable glands</b> 1 entry – Ø up to 25 mm
100	0 849 00	Standard claws Long claws	5	0 695 99	2 entries - Ø up to 16 mm
50	0 849 01				

**Plexo™ boxes**

---

**Please consult us**

## Plexo IP 55 – IK 07 modular mechanisms



Mechanisms supplied with cover plate  
 Installation with surface mounting boxes (p. 05) or flush mounting support frames (p. 05)  
 Illuminated functions supplied with 230 V $\sim$  lamps (except 0 695 43 / 0 695 44 / 0 696 33 / 0 696 34: supplied with 12 V lamps)  
 Lamps and accessories (p. 06)  
 Automatic connection

### Pack Cat.Nos Switches 10 AX - 250 V $\sim$

Pack	Cat.Nos	Switches 10 AX - 250 V $\sim$
		<b>IP 55 — IK 07</b>
10 5	0 695 11 0 695 21	Two-way switch Intermediate switch
10	0 695 12	Two-way switch with indicator
5	0 695 13	Illuminated two-way switch
10	0 695 25	Two-gang two-way switch
10	0 695 30	Double pole switch

### Switches 16 A - 250 V $\sim$

		IP 55 - IK 07
5	0 695 23	<b>Two-way switch</b> 
1	0 695 24	<b>Illuminated two-way switch</b> Supplied with 230 V $\sim$ lamp 
1	0 695 27	<b>Double pole switch</b> 
1	0 695 28	<b>Double pole switch with indicator</b> Supplied with 230 V $\sim$ lamp 

### Pack Cat.Nos Illuminated time lag switch - 250 V $\sim$

Pack	Cat.Nos	Illuminated time lag switch - 250 V $\sim$
		<b>IP 55</b>
5	0 695 04	Electronic 2-wire connection Supplied with lamp Temporization: 25 s to 15 min. Maximum loads: - 1 000 W incandescent and halogen 230 V $\sim$ - 400 W halogen 130 V $\sim$ - 400 VA ELV halogen lamps - 400 VA fluorescent lamps - 2 300 W resistive (heating)

### Push-buttons 10 A

Pack	Cat.Nos	Push-buttons 10 A
		<b>IP 55 — IK 07</b>
10	0 695 40	N/O contact
10	0 695 41	Changeover (N/O + N/C contact)
10	0 695 42	Illuminated, N/O contact
10	0 695 43	Illuminated N/O contact, with label holder Supplied with 12 V lamp Can be equipped with 230 V $\sim$ lamp (p. 673)
5	0 695 44	Illuminated changeover push button (N/O + N/C contact), with label holder Supplied with 12 V lamp Can be equipped with 230 V $\sim$ lamp (p. 673)



For availability, please consult us



## Plexo IP 55 – IK 07 modular mechanisms (continued)



Mechanisms supplied with cover plate  
Installation with surface-mounting boxes (p. 05) or flush-mounting support frames (p. 05)  
Lamps and accessories (p. 06)  
Automatic connection

Pack	Cat.Nos	Automatic switches, 230 V~
1	 0 695 00	<b>Without neutral — 2 wire connection - IP 55 - IK 07</b> Can be used instead of a 1 way switch No additional wiring required Operates: 60 to 300 W incandescent and halogen lamps 230 V~ Temporization: 6 s to 6 min. Detection angle: 130° Luminosity threshold: 3 to 1000 lux Maximum detection range: 8 m (adjustable)
1	0 695 02	<b>With neutral — 3 wire connection - IP 55 - IK 07</b> Operates: 500 to 1000 W - incandescent and halogen lamps 230 V~ - ELV halogen lamps - fluocompact Temporization: 1 s to 16 min. Detection angle: 180° Luminosity threshold: 3 to 1000 lux Maximum detection range: 8 m (adjustable)

Pack	Cat.Nos	Light sensitive switches, 230 V~
5	 0 695 17	<b>Light sensitive switch 1 function - IP 55 - IK 07</b> Can be used to switch a lighting circuit "ON" and "OFF" based on light conditions (nightfall, daybreak) Supplied in one piece, including photoelectric cell Maximum load: - 1 400 W incandescent and halogen lamps 230 V~ - 400 VA fluorescent tubes Luminosity threshold: 0,5 to 1500 lux
5	 0 695 18	<b>Photoelectric cell — IP 55</b> For use with modular light sensitive switches Cat.Nos 037 21/23/25 (p. 154)

Pack	Cat.Nos	Key operated switches 3 A - 250 V~
1	0 695 34	Supplied with RONIS key n° 455 Key removable in any position 2 positions marked "0 – I" 2 N/O contacts
1	0 695 35	2 positions marked "I – 0 – II" 2 N/O contacts

Pack	Cat.Nos	Roller blinds control Socket outlets
10	0 695 85	<b>British standard 13 A — 250 V~</b> 2P + E screw terminals
5	0 695 69	<b>RJ 45 data sockets</b> IP 55 with closed shutter IK 07 <b>Cat. 6 FTP</b> 
1	0 695 61	<b>Cat. 6 UTP</b> 
1	0 695 57	<b>Cat. 5e FTP</b> 
1	0 695 56	<b>Cat. 5e UTP</b> 



For availability, please consult us

**Plexo IP 55 – IK 07**  
modular mechanisms (continued)







0 695 47



0 695 49



0 695 83 + 0 695 91

Pack	Cat.Nos	Emergency stop functions 3 A 230 V~
1	 Grey/Yellow 0 695 47	Supplied with "emergency stop" label in 8 languages Yellow cover plate, red button  Emergency stop button 1 N/C contact 1 pole
1	0 695 48	Emergency stop with key for reset N/O + N/C contact Key RONIS n° 455 supplied Key removable in 0 position
1	0 695 49	Emergency stop - stay put 1/4 release N/O + N/C contact 
10	 Grey/White 0 695 83	<b>Pilot lamp</b> Accepts E 10 lamps – 230 V~ - 5 W max (supplied) Screw connection Supplied without diffusers (see below)
5	0 695 91	<b>Diffuser for pilot lamp</b> Red 

PLEXO 66



# The ultimate weatherproof solution

Plexo 66 ensures safety and peace of mind by delivering maintained IP 66 protections, even with moulded plugs inserted



→ Easy to install

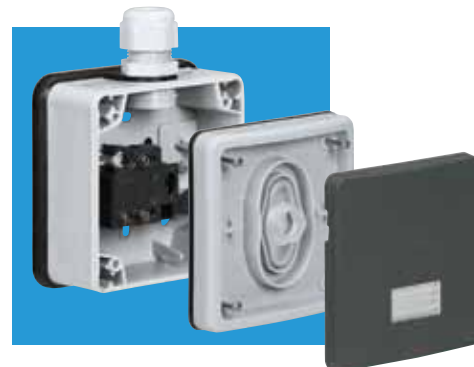

Stainless steel captive terminal screws supplied

→ Plug inserted, IP 66 guaranteed



Maintained IP 66 protection even with moulded plugs inserted

## Plexo 66 - surface mounting IP 66 - IK 08 mechanisms, boxes and accessories



6 846 19











6 846 27



6 846 28

2 finishes: - Grey RAL 7016/TO 29.- White RAL 9010

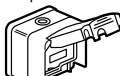
Supplied with ISO 20 membrane glands and caps (for rear cabling). Stainless steel captive terminal screws supplied in backed-off position  
Supplied without lamps

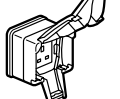
Pack	Cat.Nos	20 A - 250 V~ switches
1	6 846 03	Conform to BS EN 60 669-1 Fitted with rear gasket with groove to deposit silicone  1 gang Two-way switch - SP
1	6 846 04	 2 gang Two-way switch - SP
1	6 846 05	 1 gang Two-way switch - SP + indicator
1	6 846 06	 1 gang One-way switch - DP + indicator
1	6 846 02	 1 gang 1 way switch - DP
<b>6 A - 250 V~ push-buttons</b>		
1	6 846 11	 1 gang Two-way switch - SP with "Bell"
<b>13 A - 250 V~ fused spur units</b>		
1	6 846 45	Conform to BS 1363: Part 4 Fitted with rear gasket with groove to deposit silicone  1 gang - DP switched
<b>13 A - 250 V~ socket outlets</b>		
1	6 846 22	Conform to BS 1363: Part 2 Fitted with rear gasket with groove to deposit silicone  1 gang Switched socket with opaque lid
1	6 846 20	 1 gang unswitched socket with opaque lid
1	6 846 19	 1 gang unswitched Accepts moulded plugs with side outlet

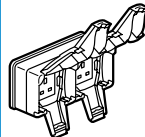
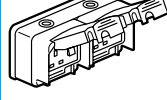
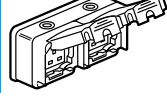
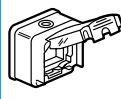
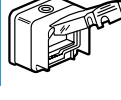
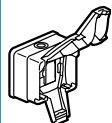
Pack	Cat.Nos	13 A - 250 V~ socket outlets (continued)
1	6 846 27	 2 gang unswitched Accepts moulded plug
1	6 846 29	 2 gang switched
1	6 846 28	 2 gang unswitched
<b>Arteor adaptors</b>		
1	Grey 6 846 36	 2 module adaptor with semi-transparent lid
1	6 846 38	 3 module adaptor with semi-transparent lid
<b>RJ 45 Socket</b>		
1	0 904 67	 Cat.6 - FTP



**Legrand Singapore  
Showroom**

15 Jalan Kilang Barat  
#07-05/06/07 Frontech Centre  
Singapore 159357

**Tel:** (65) 6861 2234

**Fax:** (65) 6416 1580

**Email:** [customerhub.sg@legrand.com.sg](mailto:customerhub.sg@legrand.com.sg)

**Website:** [www.legrand.com.sg](http://www.legrand.com.sg)